

Model B®

Spring Roller-Type Screen



SPECIFICATION DATA

SUGGESTED SPECIFICATIONS: _____ projection screen(s), _____(H) x _____(W), wall or ceiling mounting type. Screen to have a powder coated white 22-gauge octagonal steel case with flat back design and fitted with end caps concealing roller ends with integral bearing surface to support roller and integral brackets for wall mounting by means of slotted screw holes and ceiling mounting by means of powder coated hanger rings. Bottom of fabric shall be mounted securely into a powder coated tubular

steel slat. Ends of slat shall be protected by plastic caps. A steel pull bail shall be attached to slat. A 36" (91 cm) pull cord with plastic knob is included. To have masking borders standard on flame retardant and mildew resistant fiberglass fabric. Fabric shall be mounted into a metal strip in a metal Camlok® roller system without tape, glue, staples or cords so that fabric may be easily replaced yet cannot be pulled from roller.

HDTV (16:9) Format Dimensions

Viewing Area (H x W)		Nominal Diagonal		A - Overall Length of Case		B - Between Hanger Eyes		C - Brackets		D - Case Diameter (Width)		Approx. Ship. Wt.	
In.	Cm	In.	Cm	In.	Cm	In.	Cm	In.	Cm	In.	Cm	Lbs.	Kg
37½" x 67"	95 x 170	77"	196	73%"	186	72%"	184	3%"	8.6	2½"	6	15	6.8
45" x 80"	114 x 203	92"	234	87%"	222	86%"	220	3%"	9.2	2¾"	7	23	10.4
52" x 92"	132 x 234	106"	269	99%"	252	98%"	251	3%"	9.2	2¾"	7	26	11.8

(16:10) Wide Format Dimensions

Viewing Area (H x W)		Nominal Diagonal		A - Overall Length of Case		B - Between Hanger Eyes		C - Brackets		D - Case Diameter (Width)		Approx. Ship. Wt.	
In.	Cm	In.	Cm	In.	Cm	In.	Cm	In.	Cm	In.	Cm	Lbs.	Kg
50" x 80"	127 x 203	94"	239	87%"	222	86%"	220	3%"	9.2	2¾"	7	24	10.9
57½" x 92"	146 x 234	109"	277	99%"	252	98%"	251	3%"	9.2	2¾"	7	27	12.3

Video (NTSC 4:3) Format Dimensions

Viewing Area (H x W)		Nominal Diagonal		A - Overall Length of Case		B - Between Hanger Eyes		C - Brackets		D - Case Diameter (Width)		Approx. Ship. Wt.	
In.	Cm	In.	Cm	In.	Cm	In.	Cm	In.	Cm	In.	Cm	Lbs.	Kg
43" x 57"	109 x 145	72"	183	63%"	161	62%"	159	3%"	8.6	2½"	6	13	5.9
50" x 67"	127 x 170	84"	213	73%"	186	72%"	184	3%"	8.6	2½"	6	15	6.8
60" x 80"	152 x 203	100"	254	87%"	222	86%"	220	3%"	9.2	2¾"	7	24	10.9
69" x 92"	175 x 234	120"	305	99%"	252	98%"	251	3%"	9.2	2¾"	7	27	12.3

Square Format Dimensions

Sizes (H x W)		A - Overall Length of Case		B - Between Hanger Eyes		C - Brackets		D - Case Diameter (Width)		Approx. Ship. Wt.	
In.	Cm	In.	Cm	In.	Cm	In.	Cm	In.	Cm	Lbs.	Kg
40" x 40"	102 x 102	43%"	110	42%"	108	3%"	8.6	2½"	6	9	4.1
50" x 50"	127 x 127	53%"	136	52%"	134	3%"	8.6	2½"	6	12	5.4
60" x 60"	152 x 152	63%"	161	62%"	159	3%"	8.6	2½"	6	14	6.4
70" x 70"	178 x 178	73%"	186	72%"	184	3%"	8.6	2½"	6	17	7.7
72" x 72"	183 x 183	75%"	191	74%"	190	3%"	9.2	2¾"	7	19	8.6
84" x 84"	213 x 213	87%"	222	86%"	220	3%"	9.2	2¾"	7	26	11.8
96" x 96"	244 x 244	99%"	252	98%"	251	3%"	9.2	2¾"	7	30	13.6

PRODUCT NOTES

- **Matte White, Video Spectra 1.5 and High Contrast Matte White:** Surfaces will be seamless in standard sizes.
- Overall case length dimensions +/- 1/4" (6 mm).
- Specifications subject to change without notice.
- Hanger rings add 3/4" (19 mm) to the overall dimension C.
- Custom formats and sizes available upon request.
- **Optional Accessories:** to provide clearance: Furnish 6" (15 cm) heavy extension wall brackets to mount screen. To provide for keystone elimination: Furnish #11 or #23 adjustable extension wall brackets. Furnish magnetic tilt lock for keystone elimination.
- **NOTE:** Brackets also are used for mounting screen across a corner.

WHEN ORDERING, MARK APPROPRIATE SELECTIONS:

1. Select size from charts on the other side.
2. Select viewing surface (All Da-Lite surfaces are GREENGUARD GOLD Certified):
 - Matte White
 - High Contrast Matte White
 - Video Spectra 1.5
3. Optional accessories:
 - No. 6 Wall Bracket - 6" (15 cm) non-adjustable extension brackets (140#, 63.5 kg, per pair maximum) (black or white).
 - No. 11 Wall Bracket - 10" or 14" (25 or 36 cm) non-adjustable extension brackets (75#, 34 kg, per pair maximum) (black or white).
 - No. 23 Adjustable Wall Bracket - 10", 14", 15 3/4", 18 3/4", 20" or 24" (25, 36, 40, 46, 51 or 61 cm) adjustable extension brackets (75#, 34 kg, per pair maximum) (black or white).
 - Tilt-Lock for Keystone Elimination (used with extension brackets).
 - T-Bar Clip for drop ceilings (50#, 23.7 kg, per pair maximum) (black or white).
 - Pull Rod - 38" (97 cm).
 - No borders (Black masking borders standard).
 - Black case (white standard).

PRODUCT VIEWS

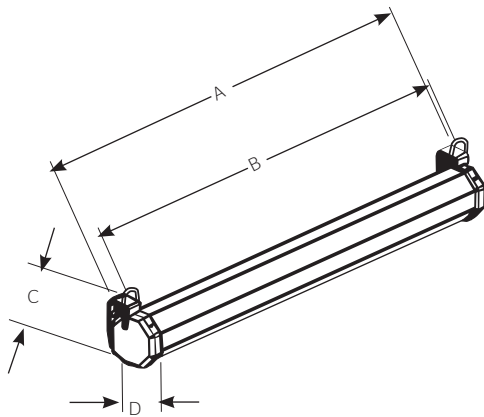

ACCESSORIES

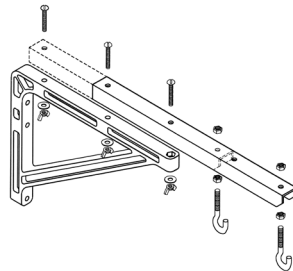

No. 23 Adjustable Wall Bracket
Screen can be extended 10", 14", 15 3/4", 18 3/4", 20" or 24" from wall by wing nut and bolt adjustment.

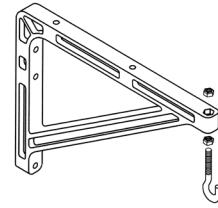

No. 11 Wall Bracket
Screen can be extended 10" or 14" from wall by changing position of bracket.

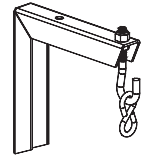

No. 6 Wall Bracket
Screen can be extended 6" from wall.

Extension Wall Brackets

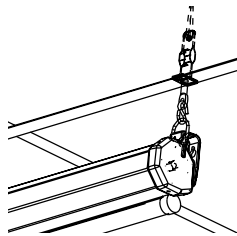

T-Bar Clip for drop ceiling, 50 lb. capacity.

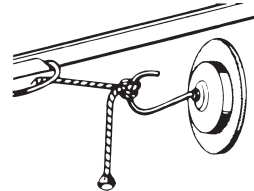

Tilt Lock for Keystone elimination. Used with extension brackets.

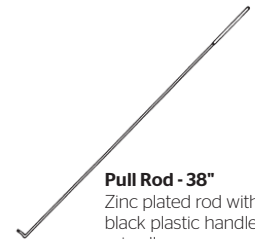

Pull Rod - 38"
Zinc plated rod with black plastic handle grip allows easy access to screen when mounted out of reach. Also can be used as a pointer.



A BRAND OF MILESTONE AV TECHNOLOGIES

www.milestone.com
P 800.622.3737 / 574.267.8101
F 877.325.4832 / 574.267.7804
E info@da-lite.com

In British Columbia, Milestone AV Technologies ULC carries on business as MAVT Milestone AV Technologies ULC.

©2017 Milestone AV Technologies. DL-0224 (Rev. 1) 0617.
 Da-Lite is a registered trademarks of Milestone AV Technologies. All other brand names or marks are used for identification purposes and are trademarks of their respective owners. All patents are protected under existing designations. Other patents pending.

Project Name: _____

Architect: _____

Contractor: _____ Phone: _____

Reseller: _____ Phone: _____